

# Increased Temperature Effect on Induction Motor Parameters

Noura A. Nour Al-Din<sup>1</sup>, Hamed A. Ibrahim<sup>2</sup>, Salah A. Abdel Maksoud<sup>3</sup>, Sobhy S. Dessouky<sup>4</sup>

## ABSTRACT

This paper studies the effects of increased temperature on the performance of the three phase induction motor. An electrical, mechanical, and thermal model of an induction motor is used to study the change of the motor parameters. The proposed model is developed using Matlab-Simulink. The experimental work is implemented in order to investigate the effect of temperature rise on the induction machine. Simulation and experimental results were obtained to monitor the effects of increased temperature on the stator resistance, stator current, rotor speed, stator flux and motor torque at different loads.

**Keywords**— *Induction motor, Thermal model, Mathematical model, Performance of induction motor.*

## 1. Introduction

This paper is concerned with increasing the temperature on the performance of the induction motors. Squirrel cage is a common type of induction motors. It uses because of its good reliability and cost. The increased temperature inside operating machine, which is very near to being accurate. The variation of temperature rise with time during heating and cooling has been modeled and investigated in [1-3].

The reasons behind studying the effect of increasing temperature on the performance of the three phase induction motors are:

- Increasing the mechanical loads on the motor.
- Motor braking.
- Increasing the temperature due to short circuit current.

## 2. Modelling of Induction Motor

A complete model is developed helps to analyze the induction motor as shown in Fig. 1. In electrical model, the input includes the voltage and the slip which are affected by torque.

The thermal model can be determined by increasing heat. The increasing of temperature is caused by flowing the current in the conductor that can be determined by thermal capacity in watts, thermal resistance, and the rotor slip. The thermal model is used to determine the rotor temperature  $\theta_e$ , which occurred from the initial condition based on the initial temperature,  $\theta_0$  [4-6]. The proposed model is done and developed using Matlab-Simulink.

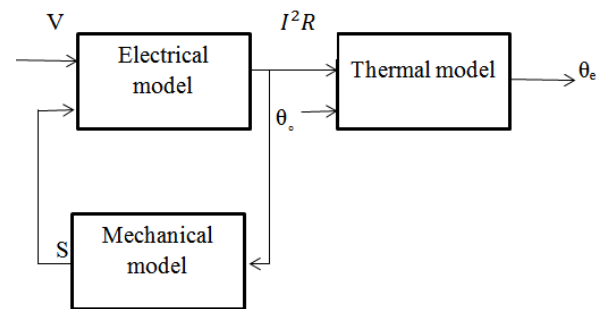

Fig. 1: Block diagram of the induction motor model.

<sup>1</sup> Noura A. Nour Al-Din is with Department of Electrical Engineering - Suez University, Suez, Egypt  
(e-mail: [eng\\_noura11111@yahoo.com](mailto:eng_noura11111@yahoo.com)).

<sup>2</sup> Hamed A. Ibrahim is with Department of Electrical Engineering - Suez University, Suez, Egypt  
(e-mail: ).

<sup>3</sup> Salah A. Abdel Maksoud is with Department of Electrical Engineering - Port Said University, Port Said, Egypt  
(e-mail: [salahahmed03@yahoo.com](mailto:salahahmed03@yahoo.com)).

<sup>4</sup> Sobhy S. Dessouky is with Department of Electrical Engineering - Port Said University, Port Said, Egypt  
(e-mail: [sobhyserry@yahoo.com](mailto:sobhyserry@yahoo.com)).

## 3. The Electrical Model

Consider the rotor windings terminals at the short-circuit, as in the usual case, the equations of the three phases of the stator and the rotor is expressed by two vectorial equations each of dimensions (3 by 1) [7, 8]:

$$\begin{aligned} \mathbf{v}_s''' &= \mathbf{R}_s \mathbf{I}_s''' + \frac{d\boldsymbol{\psi}_s'''}{dt} \\ 0 &= \mathbf{R}_r \mathbf{I}_r''' + \frac{d\boldsymbol{\psi}_r'''}{dt} \end{aligned} \quad (1)$$

Where  $^{(III)}$  denotes (a,b,c) refers to three phase (a, b, c) vector variables.  $V_s$  is the stator phase voltage vector,  $I_s$  is the stator phase current vector,  $I_r$  is the rotor phase current vector,  $R_s$  is the stator phase resistance,  $R_r$  is the rotor phase resistance and  $\Psi_s, \Psi_r$  are the stator and rotor flux linkage vectors respectively.

In equation (1), the stator and the rotor quantities are expressed in a fixed frame and a frame rotating at the rotor electrical speed respectively. Usually the motor is operated in balanced three phase conditions therefore the three phase equations for stator and rotor can be only reduced to only two equations, by applying the so called two phase transformation. The three phases (a,b,c) are first transformed to the equivalent ( $\alpha, \beta, 0$ ) phases and under the assumption of balanced three-phase operation the (0) phase equation become trivial and is thus eliminated. The two-phase power invariant transformation is given by (2) Where  $T_{2\phi}$  is the transformation matrix.

$$^{(III)} = T_{2\phi} ^{(II)} \quad (2)$$

$$T_{2\phi} = \sqrt{\frac{2}{3}} \begin{bmatrix} \frac{1}{\sqrt{2}} & 0 & 1 \\ \frac{1}{\sqrt{2}} & -\frac{\sqrt{3}}{2} & -\frac{1}{2} \\ \frac{1}{\sqrt{2}} & \frac{\sqrt{3}}{2} & -\frac{1}{2} \end{bmatrix}$$

Where dropping the (0) phase, the electrical equations reduce to (2 by 1) vector equations:

$$\begin{aligned} V_s'' &= R_s I_s'' + \frac{d\Psi_s''}{dt} \\ 0 &= R_r I_r'' + \frac{d\Psi_r''}{dt} \end{aligned} \quad (3)$$

Where the stator quantities are still expressed in a fixed frame and the rotor quantities are in a frame rotating at the electrical speed of the rotor denoted by  $\omega_e$ .

The rotor electrical speed is related to the number of pole pairs of the motor ( $p$ ) and the mechanical speed ( $\omega$ ) of the rotor by the relation:

$$\omega_e = p\omega \quad (4)$$

Dealing with these quantities in the two different frames are quite difficult so that both of them are transformed to an arbitrary frame, rotating at speed  $\omega_a$  by applying another transformation  $Tdq_s$  and  $Tdq_r$  which are (2x2) Transformation matrices for stator and rotor respectively as follows:

$$\begin{aligned} Tdq_s &= \begin{bmatrix} \cos \theta_s & \sin \theta_s \\ -\sin \theta_s & \cos \theta_s \end{bmatrix} \\ Tdq_r &= \begin{bmatrix} \cos \theta_r & \sin \theta_r \\ -\sin \theta_r & \cos \theta_r \end{bmatrix} \end{aligned} \quad (5)$$

Applying this transformation to the motor equations, the two phase electrical equations of the induction motor in an arbitrary frame rotating at speed  $\omega_a$  are given by:

$$\begin{aligned} V_s &= R_s I_s + \frac{d\Psi_s}{dt} + \omega_a J_2 \Psi_s \\ 0 &= R_r I_r + \frac{d\Psi_r}{dt} + (\omega_a - \omega_e) J_2 \Psi_r \\ J_2 &= \begin{bmatrix} 0 & -1 \\ 1 & 0 \end{bmatrix} \end{aligned} \quad (6)$$

The mechanical equation can be written as:

$$J \frac{d\omega}{dt} + b\omega = T - T_L \quad (7)$$

$J$ : the inertia of the motor,  $T_L$ : the load torque.

#### 4. The Thermal Model

The main goal of this modeling is selecting the appropriate rating of a motor in order to operate with the safe limit without any exceeding the temperature. The developed model will be applied to protect increasing temperature [9]. The input of thermal model includes the stator current and the output temperature. For a given load, the input parameters are: 50 Hz, 380 V (line voltage), and load torque (0, 0.5, 1, N.m.). Matlab-Simulink program has been developed to solve the thermal problems. Fig. 2 gives a block diagram of the thermal model [9-11].

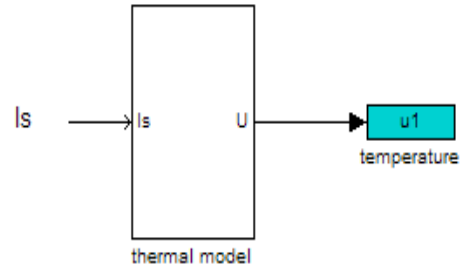

Fig. 2: A block diagram of the thermal model.

It can be noticed that, the differential equation for the increased temperature in a conductor by neglecting heat loss can be expressed by equation (8) [4]:-

$$I^2 R = C_T \frac{d\theta}{dt} \quad (8)$$

Where

$I^2 R$ : the input watt (conductor loss)

$C_T$ : the thermal capacity of the conductor in watt-sec. /°C

$\frac{d\theta}{dt}$ : the rate of change of temperature in °C/second.

The equation can be integrated to find the increased temperature:

$$\theta = \frac{1}{C_T} \int_0^t I^2 R . dt \quad (9)$$

Fig. 3 shows the thermal model of the induction motor using Matlab-Simulink.

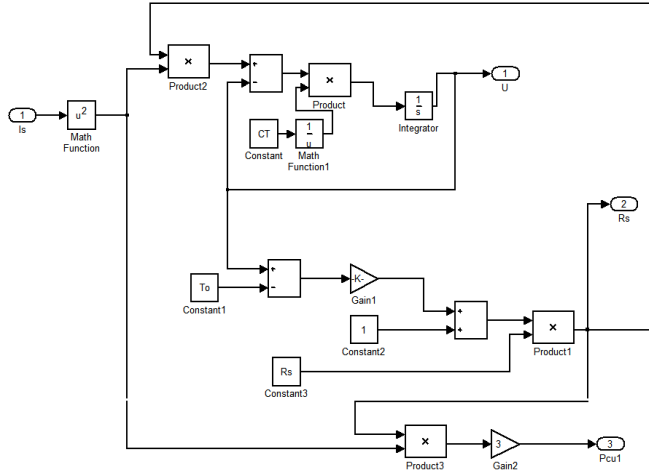

Fig. 3: Matlab-Simulink thermal model.

The induction motor thermal model used in temperature measurement is developed by Matlab using the appropriate equations at various loads. Stator thermal model will be implemented by using equation from 8 to 10. Fig. 4 shows the stator thermal model;

$$I_s^2 R_s = C_t R_s \frac{d\theta}{dt} + \theta_o \quad (10)$$

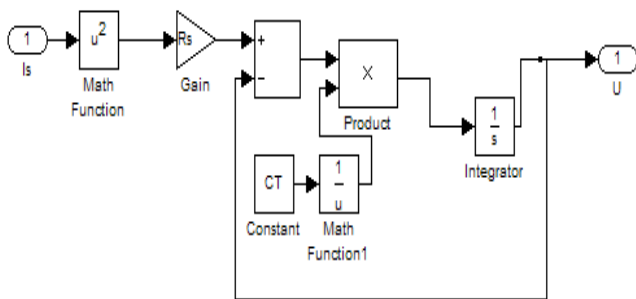

Fig. 4: Stator thermal model.

## 5. Simulation Result

Simulation of the thermal model is performed by considering various conditions such as normal state, number of starts state and number of trips state. The induction motor used in this simulation model has the following parameters: three phase induction motor, F=50 Hz, P= 370 W, V=380, W= 1365 rpm, Rs=30 Ω, Rr=20 Ω.

Fig.5 shows the variation of the thermal temperature with time at different applied torque (0, 0.5 and 1 N.m) respectively. It

can be noted that the temperature is increased by increasing the applied torque. This occurs due to motor draw more current with an increase in load. As can be seen from this figure, the motor has reached thermal equilibrium. Also, this figure indicates that the temperature of motor increases at higher rate with increasing the load. the speed variation with temperature

at different loads, where the speed decreases with temperature rise, because the load torque increase with increase the temperature at different loads, and the torque inversely proportional with the speed. Therefore the speed decreases with temperature rise, as shown in Fig.6. Fig.7 shows the motor torque variation with temperature, where the torque increases with temperature rise. The curve is nearly linear between no load and full load. In this range, the rotor resistance is much greater than the reactance, so the torque increase with the slip. Hence, the torque increases with temperature rise. Fig. 8 shows the increase of the slip with temperature rise at different loads. The rotor resistance is much greater than the reactance, so the torque increase with slip, and the slip directly proportional with torque, so the slip increase with temperature rise. Fig. 9 shows the variation of the output power with temperature at different loads, where the output power increase with temperature rise, as the torque directly proportionally with power so the output power increase with temperature rise. Fig. 10 shows the stator resistance variation with temperature, whereas the stator resistance increases with temperature rise. Specific resistance of a material may change with temperature; they also change resistance according to temperature by certain amount. For pure metals, this coefficient is a positive number, meaning that the resistance increase with increase temperature. The stator current decrease with temperature rise. Thereby, the resistance inversely proportionally with the current, hence the stator current decrease with temperature rises is shown in Fig. 11. Fig 12, the variation of the rotor copper losses, where the rotor copper losses increasing with temperature rise. The temperature rise is due to heat generated by motor rotor copper losses during operation, this losses increase with temperature rise.

Fig. 13 shows the variation of the rotor current with temperature, whereas the rotor current increases with temperature rise. The rotor resistance is the same value at different loads as shown in Fig.14.

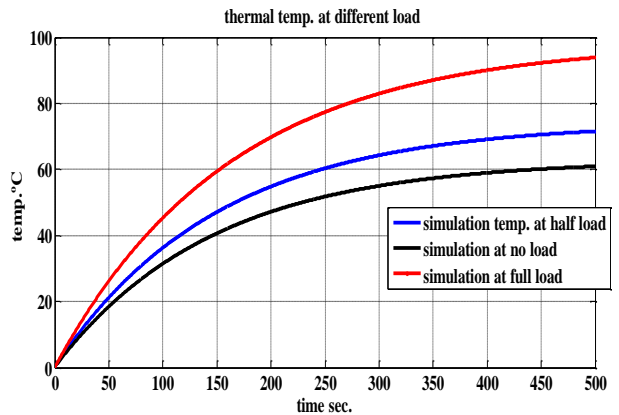

Fig. 5: Variation of the thermal temperature with time at different loads.

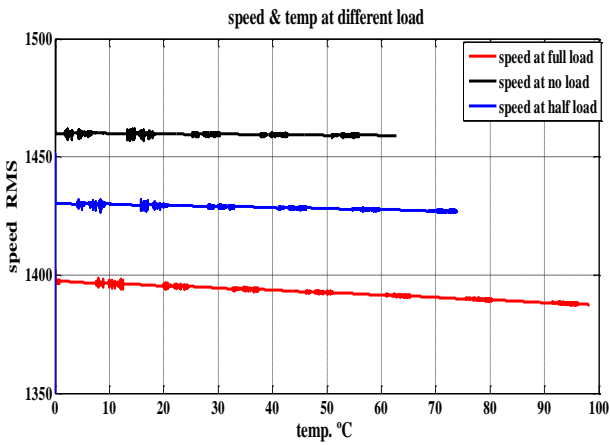

Fig. 6: Variation of the speed with temperature at different loads.

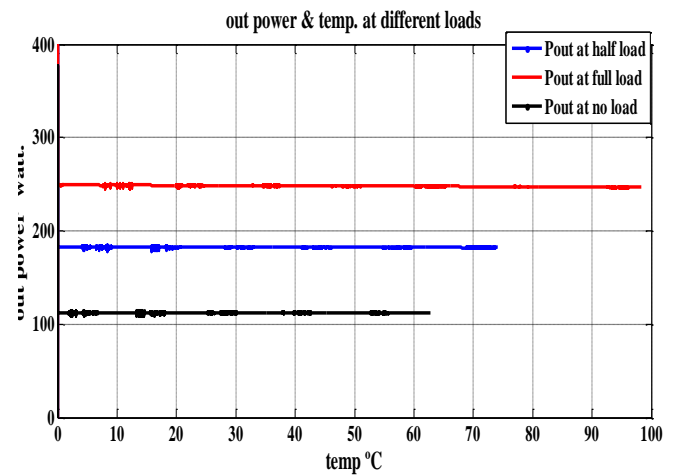

Fig. 9: Variation of the output power with temperature at different loads.

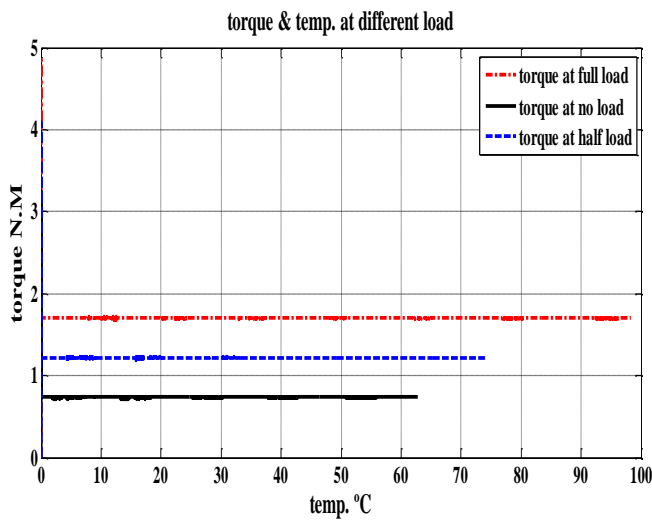

Fig. 7: Variation of the motor torque with temperature at different loads.

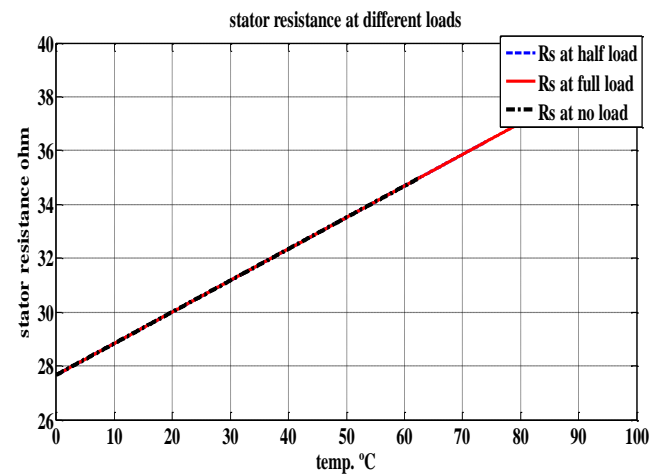

Fig. 10: Variation of the stator resistance with temperature at different loads.

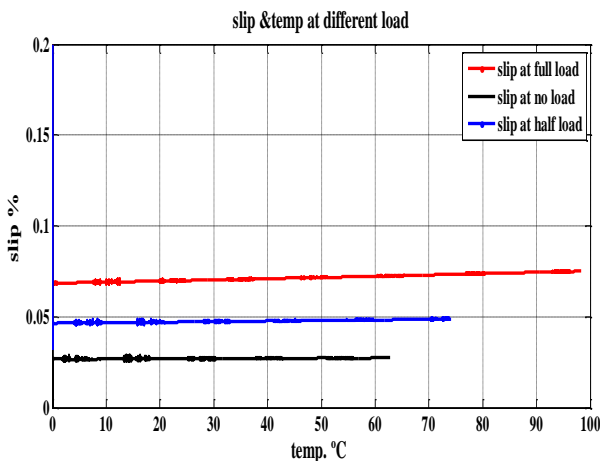

Fig. 8: Variation of the slip with temperature at different loads.

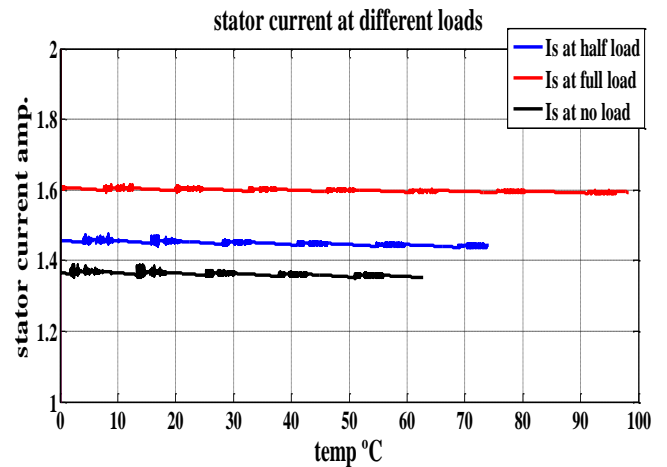

Fig. 11: Variation of the stator current with temperature at different loads.

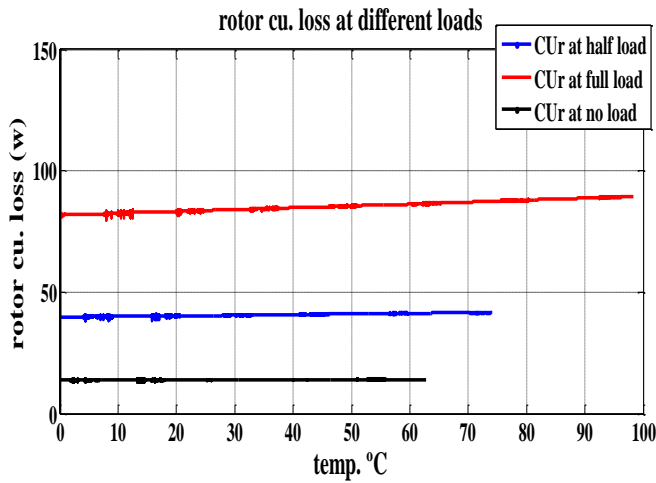

Fig. 12: Variation of the rotor cu. loss with temperature at different loads.

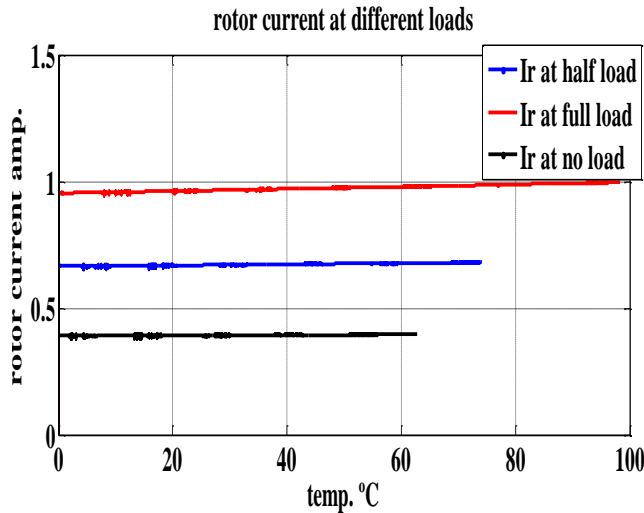

Fig. 13: Variation of the rotor current with temperature at different loads.

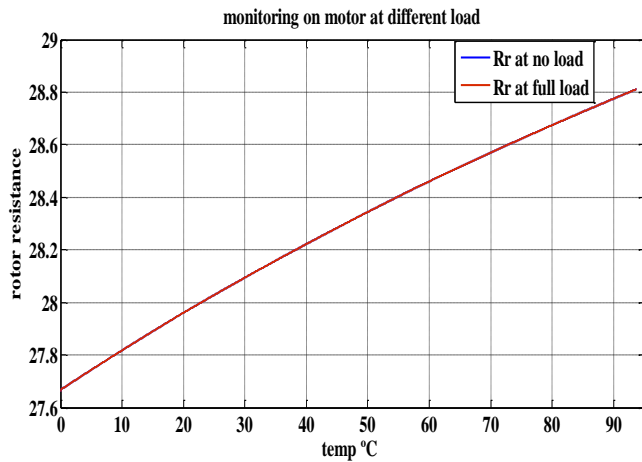

Fig. 14: Variation of the rotor resistance with temperature at different loads.

## 6. Experimental setup and Test Method

The experimental setup of induction motor is shown in Fig. 15. A 370 W, 4 poles, small induction motor with insulation class C is used. Insulation class C has the allowable temperature threshold at 393K. The input parameters are: 50 HZ, 380 V (line voltage), and different values of load torque 0, 0.25, 0.5, 0.75, 1 N.m. The value of load torque can be varied mechanically or feeding separately excited DC generator with resistive load. In the laboratory, resistive load is used because the mechanical load is not available. More current will be drawn by the motor with the increasing of the load torque. This leads to an increasing in the motor temperature.

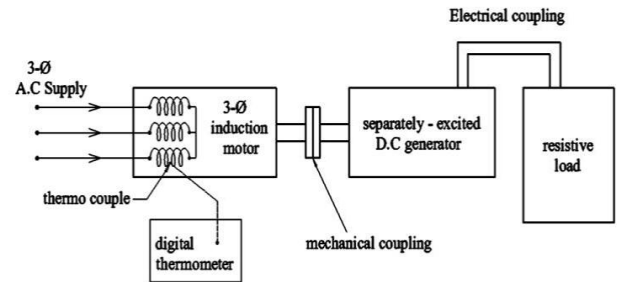

Fig. 15: Experimental setup diagram.

## 7. The experimental results

The experimental and simulation results of the increased temperature on the performance of the induction motor at different values of load torque. Fig. 16 shows the experimental and simulation results of variation the temperature with time variation at different loads. It can be noticed that the temperature increases with the increase in the load torque. The simulation and experimental results of speed variation with temperature at different loads are shown in Fig. 17. Also, the speed decreases with the increase in load torque at fixed temperature in the theoretical and experimental results. Fig. 18 shows the variation of slip with temperature variation at different loads, but in the experimental temperature removed the initial temperature (30°C) until begin from zero. It can be noticed that the slip increases with the increasing in load torque at fixed temperature in the experimental results, but in the simulation results, it increases by a small rate. The variation of the motor torque with temperature at different loads is shown in Fig. 19. It shows the increase of the motor torque with the increasing load torque at fixed temperature in the simulation and experimental results.

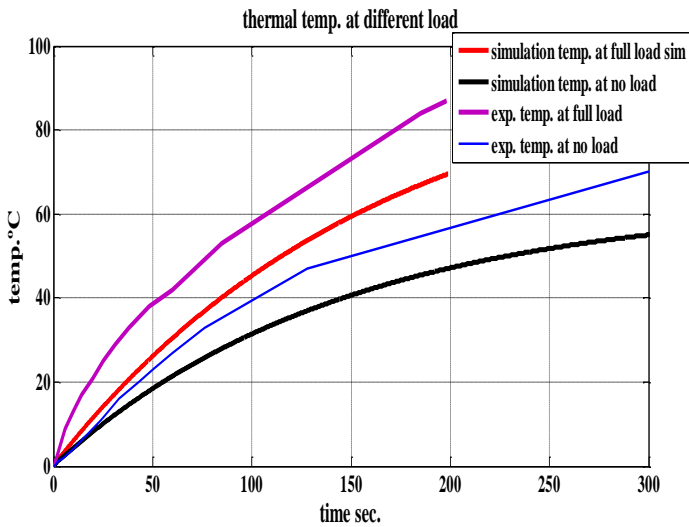

Fig. 16: Variation of the temperature with time at different loads.

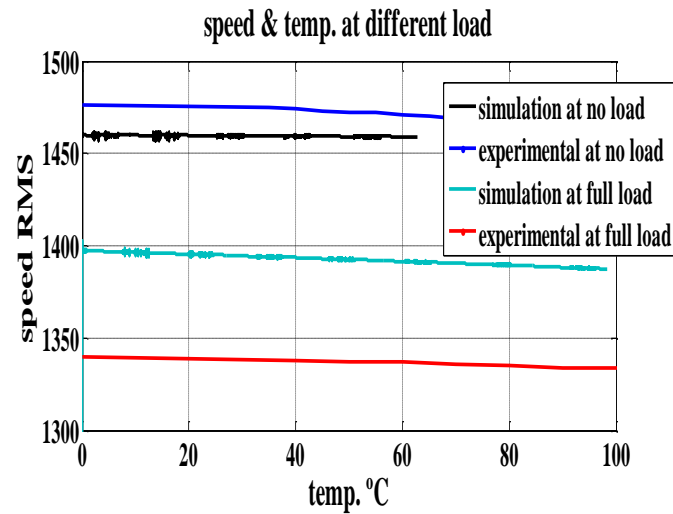

Fig. 17: The speed variation with the temperature at different loads.

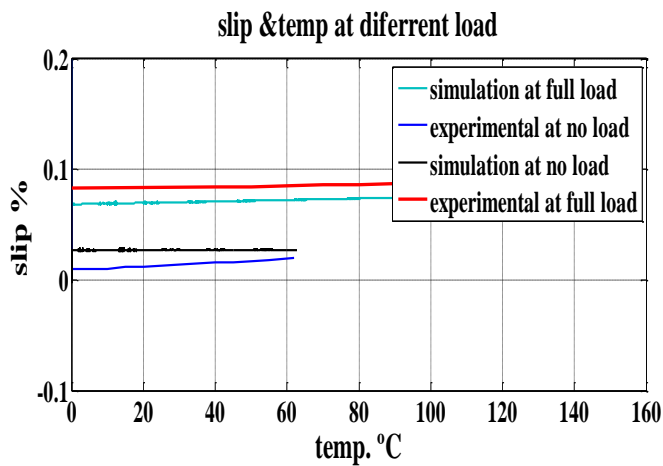

Fig. 18: The variation of slip with temperature at different loads.

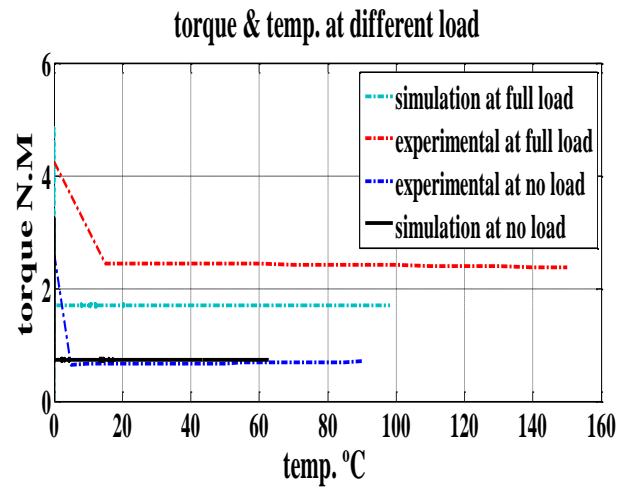

Fig. 19: Variation of the motor torque with temperature at different loads.

## 8. Arduino

Arduino is an open-source microcontroller development board. The Arduino is used to read sensors and control things like motors and lights. The motor temperature is monitoring and display instantaneously using Arduino to know motor state, study the effect of increased temperature on the induction motor parameter and display in computer. Fig.20 shows the variation of the temperature with time at different loads by using Arduino. It is illustrated that, the temperature is increasing with increasing the working hours of operation.

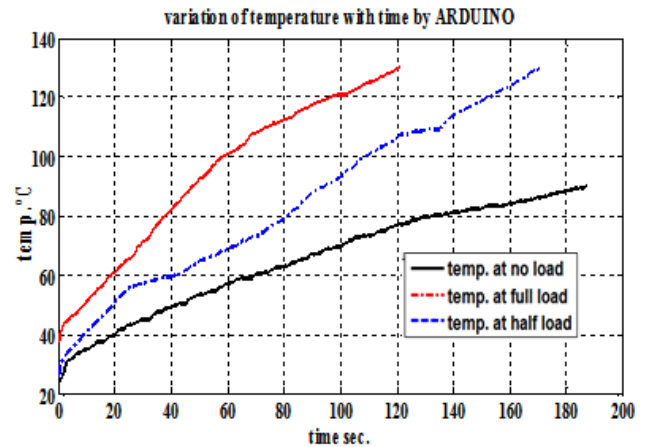

Fig. 20: Variation of the temperature with time at different loads by using Arduino.

## 9. Conclusion

The proposed method implemented experimentally and simulated by using MATLAB-Simulink program. The studied parameters that effect on the temperature rise in an induction

motor at different loads can be obtained as the following; the motor temperature is increased with increasing the working hours of operation. According to increase the motor temperature, the motor speed is decreased because the load torque become has a high value. The insulation resistance is decreased with any increases of the winding temperature. The stator current is decreased with any increases of the winding temperature. The slip is increased with any increases of the winding temperature. It is concluded also from this study, the efficiency of the motor became poor with any increases of winding temperature due to increases of the motor losses. The motor temperature is monitoring and display instantaneously using Arduino to know motor state, study the effect of increased temperature on the induction motor parameter and display in computer.

## Reference

- [1] B. E. ElSaid, "Effect of temperature variation of electrical insulation on the performance of electrical machines," M.c. Thesis, Suez-Canal University, November 2008.
- [2] Kimotho, J," Evaluation of the Effect of Operating Parameters on Thermal Performance of an Integrated Starter Generator in Hybrid Electric Vehicles" No. 2011-28-0134; SAE International: Warrendale, PA, USA, 2011.
- [3] Lim, D.H.; Kim, S.C. "Thermal performance of oil spray cooling system for in-wheel motor in electric vehicles". *Appl. Therm. Eng.* 2014, 63, 577–587.
- [4] W. Penrose," Repair Specification for low Voltage Polyphase Induction Motors Intended for PWM Inverter Application," Ph.D. Thesis, Kennedy-Western University, 2001.
- [5] J. K. Kim, S. Kwak, "Optimization of Multilayer Buried Magnet Synchronous Machine Combined with Stress and Thermal Analysis," *IEEE Trans. on Magnetics*, vol. 42, no. 4, pp1023-1026, Apr. 2006.
- [6] M.S. Rajagopal,K.N.," Transient Thermal Analysis of Induction Motors," *IEEE Trans. on Energy Conversion*, vol. 13, vo. 1, March 1998.
- [7] Nandi S., "Condition Monitoring and Fault Diagnosis of Electrical Machines – A Review", Conference 1999. Thirty-Fourth IAS Annual Meeting, Vol. 1, 1999.
- [8] E. Darie, E. Darie, "About Modeling of Induction Motor Faults", 6th International Conference on Electromechanical and Power Systems, Rep. Moldova, pp. 172–175.
- [9] S. Rajagopalan, "Nonstationary Motor Fault Detection Using Recent Quadratic Time–Frequency Representations", *IEEE Transactions On Industry Applications*, vol. 44, no. 3, pp. 735-744, May/June 2008.
- [10] B. Li, M. Chow, "Neural-Network-Based Motor Rolling Bearing Fault Diagnosis" *IEEE Transactions On Industrial Electronics*, vol. 47, no. 5, pp. 1060-1069, October 2000.
- [11] F.Zidani,"Induction Motor Stator Faults Diagnosis by a Current Concordia Pattern-Based Fuzzy Decision System", *IEEE Transactions on Energy Conversion*, vol. 18, no. 4, pp. 469-475, December 2003.